

GUBI

Stemlite Wall Lamp

BY BILL CURRY

Consumer availability from September 2021



THE DESIGNER

Bill Curry

American designer Bill Curry (1927-1971) captured the zeitgeist of the 1960s and '70s with his iconic lamp designs. From his unique Los Angeles vantage point at the meeting point of art, design and engineering, he translated the wonder and delight he saw around him into simple yet intelligent ideas with clear visual narratives.





A new addition to the Stemplite family

The Stemplite, designed in 1962, was the first 'total look' lamp, a pioneering new typology conceived by Curry that replaced the traditional base-plus-shade form with a single self-contained unit comprising interchangeable modules. In 1965, it was named "most influential lamp of the year" by Industrial Design Magazine.

In 2020, GUBI reintroduced the forgotten design hero by putting the Stemplite Floor Lamp and Stemplite Table Lamp back into production, and since then, it has become a popular choice for residential, commercial and hospitality settings.



THE INSPIRATION

A collection that captures the mood of the space age

Influenced by Curry's background in aerospace, its bold new form captured the mood of optimism that characterized America in the era of the space race in the 1960s and '70s. The Stemplite's debut design was named "most influential lamp of the year" by Industrial Design Magazine in 1965, was featured on the set of the original Star Trek TV series and remained in production until 1977.





A new icon brought to life with drawings from the past

Designed by Bill Curry in the 1960s, the Stemlite Wall Lamp has been out of production for many decades. Now, working from Curry's own drawings after more than half a century, GUBI has restored the great American designer's vision for a wall-mounted addition to his iconic Stemlite Collection.



An organic appearance on the wall

The new Stemplite Wall Lamp appears to grow organically out of the wall, with a steel arm that extends directly outwards before turning up 90 degrees to be topped with a bulbous frosted glass shade in keeping with the rest of the Stemplite Collection

A touch of warmth for any type of room

As a feature or hallways and stairwells, or as light above a nightstand, the Stemlite Wall Lamp will add a touch of warmth and elegance to homes and hotels, evocative of a prior era while capturing the current design zeitgeist.





Introducing a dimmer function to the Stemlite Collection

Available in Black Chrome, The Stemlite Wall Lamp comprises a die-cast aluminium base, a steel arm evocative of a tulip stem, topped with the mouth-blown glass globe.

A new dimmer feature has been added across the Stemlite collection (except on the pendant) so that the light can be adjusted to set the perfect level of ambient lighting within an interior space.





The full Stemplite Collection

PRODUCTS



Stemplite Table Lamp
H42 cm



Stemplite Floor Lamp
H110 cm



Stemplite Pendant
Ø38 cm



Stemplite Table Lamp
H70 cm



Stemplite Floor Lamp
H150 cm



NEW Stemplite Wall Lamp*
Ø32 cm
**Only in Black Chrome*

MATERIALS

Shade

Frosted Glass

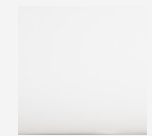

Base

Black Chrome Red Black

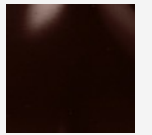
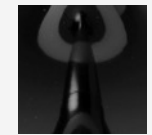

Pebble Grey

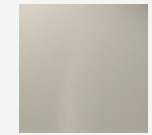

CERTIFICATIONS

CE and ETL



Stemlite Wall Lamp

DETAILS

Key dates

July 1st, 2021:
Announcement Newsletter,
Virtual Partner Kick-off and Launch
Package Uploaded

Early September 2021:
Last Orders from Partners for Launch
(Europe)

Late September 2021:
In-store availability, Stemlite Wall Lamp

November 2021
In-store availability, Full Stemlite Collection
with dimmers - excluding Stemlite Pendant

Sales samples

No sales samples for Stemlite Wall
Lamp. All salespeople should have
a Stemlite Table Lamp to represent
the collection

Other details

Only CE-certified for September
launch. ETL certified variants
available in November



Stemlite Wall Lamp

PRICES & DIMENSIONS

RRP	Black Chrome		
	EUR Incl. VAT	DKK Incl. VAT	USD Excl. VAT
Stemlite Wall Lamp	559	3.995	795

Weight: 3,55 kg
Shade Ø – 31,8 cm, Base Plate Ø – 18,2 cm, H – 42,6 cm

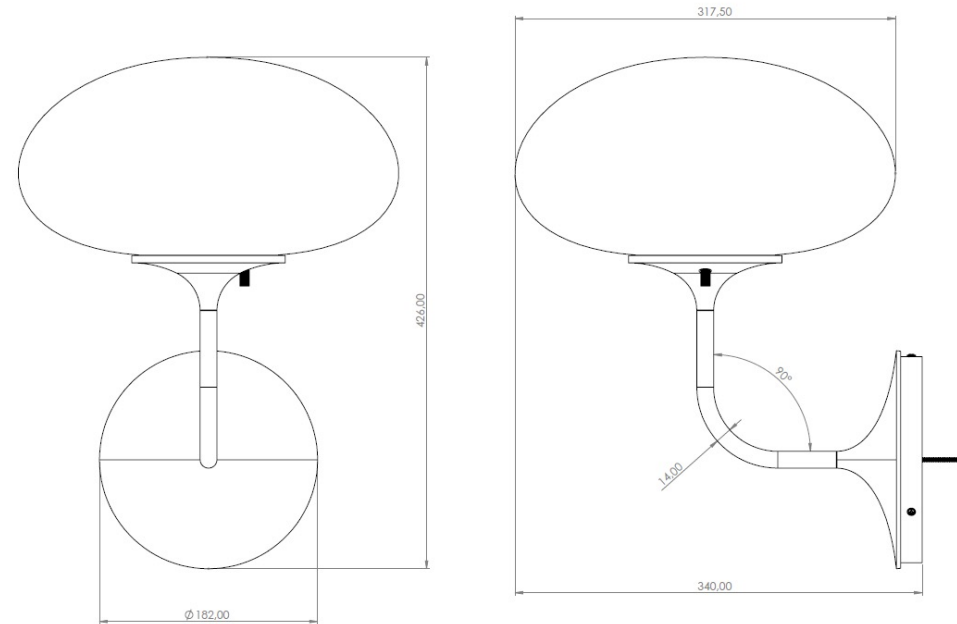

Marketing package



Packshots & lifestyle images

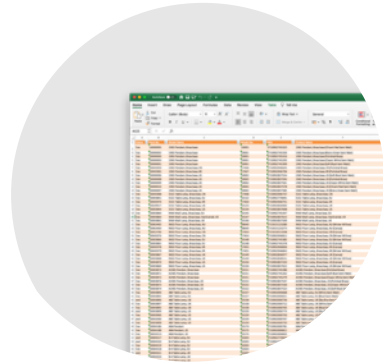

Digital Price List



GTM & Sell-in presentation



Sample
(Table Lamp only)

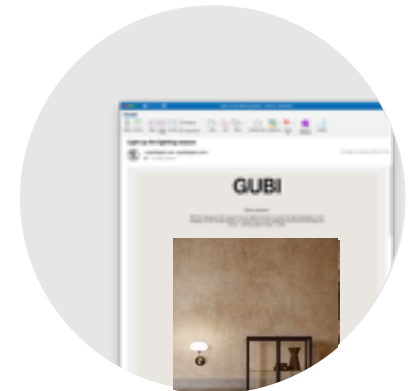

Newsletter



GUBI

